

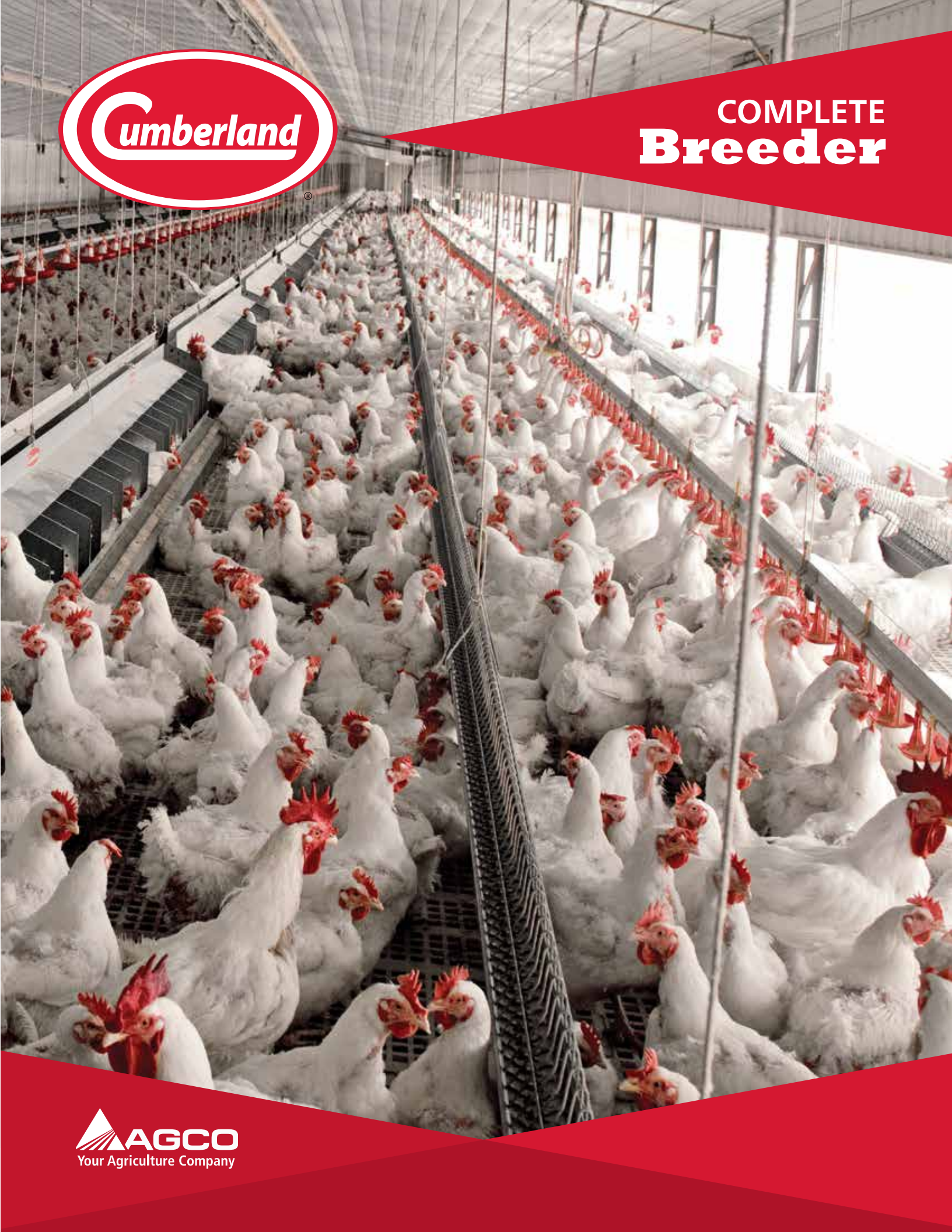

COMPLETE
Breeder



Feeding Systems

Cumberland offers a feeding system to accommodate the specific needs of your breeders, pullets and males. All systems are designed for flexibility, low maintenance and reliability to keep down both installation and operating costs.



Breeder Pan Feeder

- Three styles of grills
- Roosters restricted vertically and horizontally from accessing the hens feed
- Two-piece drop tube for ease of installation or replacement
- Sturdy, all plastic anti-rotation clip
- Durable plastic construction



Pullet Feeder

- Specially molded, low volume, waffle pan
- Restrictor tubes limit the amount of feed within the feeder drop tube which promotes uniform feed distribution throughout the feed line
- Sturdy, all plastic anti-rotation clip
- Durable 8-spoke plastic construction



Male Feeder

- Multiple levels of feed depth
- Optional slide shut-off
- Shallow design for easy access
- Feed saver lip to reduce raking
- Sturdy, all plastic anti-rotation clip
- Durable 8-spoke plastic construction



Used in conjunction with Cumberland's ribbed tubing, a sturdy, all plastic anti-rotation clip is easy to assemble and keeps the pan stationary on the line for proper operation and reduced feed spillage. An optional, all plastic, slide shut-off is available. Easy to install, the slide shutoff allows any combination of feeders to be shut-off from feed.



A durable plastic Overflow Bypass Funnel is available for the Hi-Lo Pullet and Male feeder control pans to redirect any feed that may have escaped falling through the control pan drop tube conveniently back into the feed pan.



Micro Switch Control Pan

All single phase motors feature an industry proven centrifugal actuator design. Bleed resistors have been added to all motors with capacitors to reduce heat buildup for frequent start applications. Cumberland 50/60 Hz feeding motors come with a two year warranty.



IR-Plus™ Feed Sensor

The IR-Plus™ is specially designed to work hand and hand with Cumberland's Flex-Flo™ feed delivery system and i-plus3 Control Pan. This combination of dependable Cumberland products provide gentle feed handling, full hoppers and feed pans that will result in maximum feed efficiency.

- Adjustable time delay prevents the fill system from short cycling, extending motor and auger life
- Infrared sensors accurately detect feed flow to shut fill systems off when the hopper is full
- No moving parts or sensitivity adjustments for low maintenance, accurate feed levels every time
- Easy installation and retrofitable, adapts to nearly all flexible auger systems
- LED lights allow quick verification of operating status

Infra-Red Feed Sensing

With no moving parts or sensitivity adjustments, the IR-Plus™ ensures the feed level switch is activated every time. When the feed level drops below the sensors and the user defined time delay has elapsed, the fill system will start, bringing feed to the desired hopper.

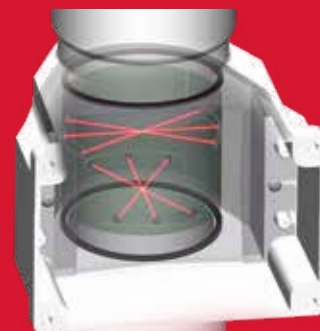

U.S. Patent 8,056,506



STANDARD HOPPER
SUSPENSION



OPTIONAL FEED HOPPER
ROTATION SUSPENSION KIT

Feed Line Hoppers

Light, durable, fully galvanized feed line hoppers are available in 120, 200, 300 and 400 lb. capacity. The standard hopper suspension allows removal of the feed hopper without affecting the feed line suspension when raising the feed lines. Optional feed hopper rotation suspension kits can be easily installed on existing or new feed lines allowing 90 degree hopper rotation with no feed hopper removal needed.

Feed Hopper Switches

The Sens-O-Matic II feed hopper switch is a reliable way to regulate your feed delivery. An optional adjustable bracket kit allows the Sens-O-Matic to be conveniently adjusted to proper operation height. Traditional micro switches, proximity hopper level controls and Flex-Flo™ hopper level control switches are also available to regulate feed delivery.



Ribbed Tubing

The rib on Cumberland's lock formed tubing gives added strength to the tube, as well as providing a solid way to hold the pans in place. The auger is manufactured from pre-flattened wire to reduce material stress and provide for a more consistent, high quality product.

Heavy fabricated, galvanized, single and double outlet boots are available for end or center house feeding applications.



Chain Feeding

Cumberland belt drive and direct drive chain feeder systems represent the classic, proven technique for even, low-stress distribution of feed. This system provides equal access to feed for all birds, promoting uniform development.

With the full range of grill patterns, trough designs and connections, suspension and hopper options, Cumberland Chain Feeder Systems can be specifically configured to meet the particular needs of the individual grower and house layout.



options, Cumberland Chain Feeder Systems can be specifically configured to meet the particular needs of the individual grower and house layout.



Pin Clock Controller

Digital Clock Controller

Simple Controls

The standard speed system (60 feet or 18.28 meters per minute) uses either a 24-hour pin clock or a 24-hour four channel digital timer, both of which can be pre-programmed to control all feeding and fill systems from the weigh bin, to the house, to the feeder.

Proven feeding system for even, low-stress distribution

A smaller trough is available for pullets and a larger trough (with a "feed saver" lip) for hens. Grills are available in almost any configuration to control access in any category.



Durable Construction

Completely enclosed in a powder coated, steel housing, the corner mechanism is specifically designed for low maintenance and high performance. Mounted on a hardened steel base plate, the corner guide rail and fluted wheel provide maximum wear resistance while assuring smooth chain movement.

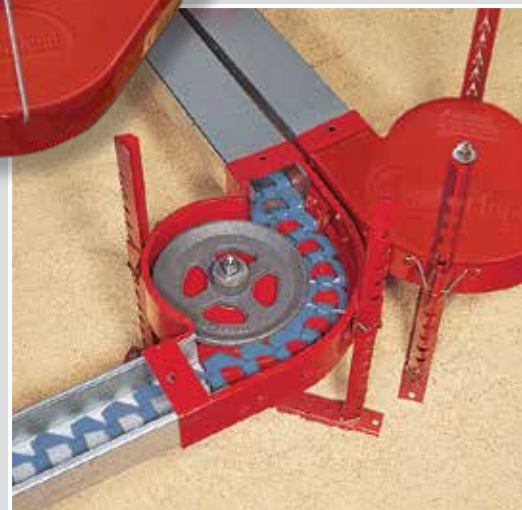

Quality Components

Cumberland's mini-hoppers are available in 50/60 Hz, 1 phase and 3 phase models. Choose from 60 or 120 feet per minute units built to last with strong weld connections and a durable multi-stage finish including shot-blasting, electrostatic powder coating and oven baked process. Mini-hoppers are available in a full range of formats and come standard with feed return wheels and feed level adjustments. Fill hoppers, maxi-hoppers and single drive unit complete our full line of feeding equipment.



Utilizing the same reliable feed return wheel and shaft as the mini-hopper and maxi-hopper, Cumberland's one line unloader adds another option for uniform feed distribution. With a weight of only 27 pounds (12.25 kg), the one line unloader is easy to handle and install.

The chain feeder Direct Drive System provides all the proven advantages of chain feeding with dependability and durability you can count on. Direct drive systems are available in 50/60 Hz, 1 phase and 3 phase models. Choose from 60, 90, or 120 feet per minute units all designed for low maintenance and efficient operation.



The assembled yoke features a precision machined design that reduces the number of parts, guarantees proper alignment and significantly enhances dependability.



Hopper extensions and lid assemblies are available in 1, 2, and 4 line models ranging in capacities from 135 lbs. to 435 lbs.



Chain, trough, and grills are engineered for strength, low maintenance and long life. Trough is available in 10' and 12' lengths. Cumberland's blue chain is available in 50' increments and features strong link connections for reliable performance. 5' and 6' grills are available in many vertical heights and horizontally spaced designs to meet all of your requirements.

Trough connecting sections are available in a full range of formats: 6", 8" and 12" (15.2cm, 20.3 cm and 30.5cm) lengths with clip-on or wrap around hangers (and heavy duty "j" hangers). Adjustable leg stands are available as well as corner in all compatible formats.



Watering Systems

Cumberland's experience and engineering continue to bring to you a complete watering system loaded with innovations and features that promote large healthy birds and dry floors.

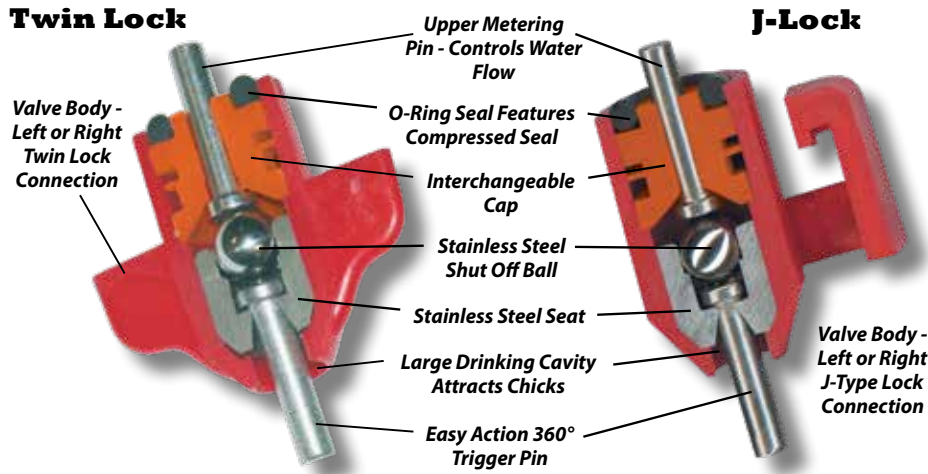

Twin Lock/J-Lock Nipple Valves

Six different nipple valves are available to meet your watering needs. A stainless steel upper pin provides long life and a precise flow rate. The valve design consists of only 3 moving parts for consistent and reliable operation. Twin Lock valves allow a wrench free assembly.

Support Options

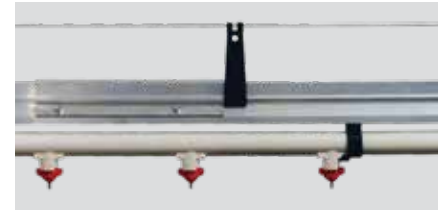

Aluminum Rail

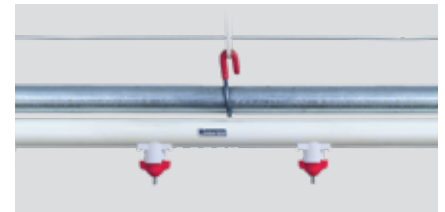

Round Pipe

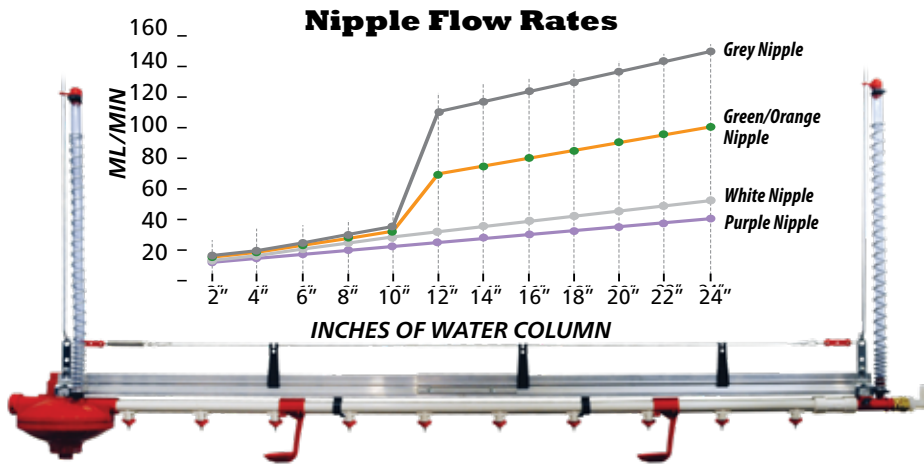

Drinking Cups

The easy to install drink cup is available as an option on Cumberland's watering systems.



Support Rail Joints

Cumberland's aluminum rail join connectors are easy to install and provide a robust fit for your connection needs.



US Patent No. 7,090,261

Water Tight Connections

- External sealing "O-ring" connection allows unobstructed water flow
- No glue necessary
- 1.05" (27 mm) large volume pipe
- Simple push together assembly
- Keyed connection from regulator to end assembly
- Light resistant water pipe prevents algae

Self Sealing Caps

Self sealing caps are used at the clear sight tube to help prevent water spillage.

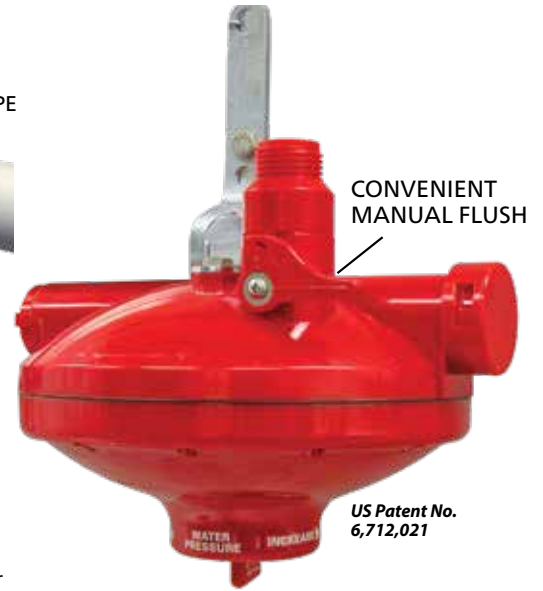

Water Regulators

Cumberland's versatile water regulator is designed for ease of use with no by-pass necessary. It can be easily removed from the watering line without interfering with the watering line suspension.



Use as a mid-line regulator by simply removing the end cap

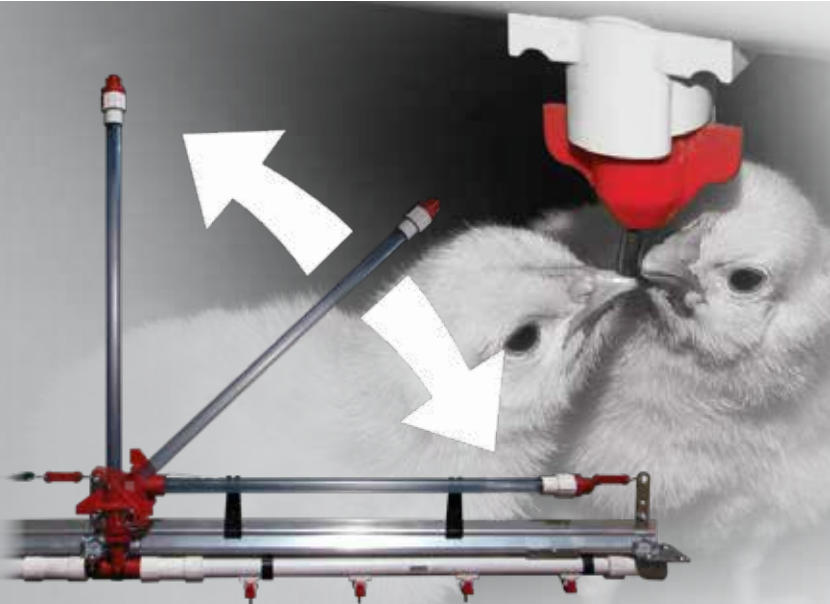

Collapsible Rigid Pipe

An optional collapsible rigid stand pipe is available providing unencumbered raising of the watering line.

Cumberland nipple valves feature 360° side-to-side toggle action, plus an increased flow rate with vertical lift action.

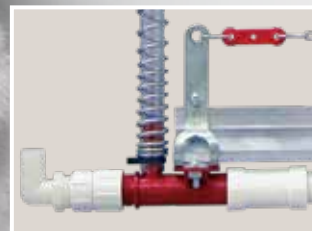

End Kit

- Tall flexible sight gauge allows for easy pressure reading
- Garden hose drain

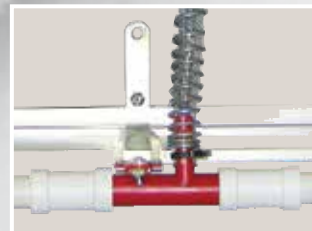

Air Vent

- Bleeds air from high spots
- Offers mid-line sight gauge reading

For reliable, low maintenance watering look to Cumberland and HH₂O Watering Systems.

Cumberland's HH₂O watering systems are designed to meet the demands of today's broad poultry production needs. For Breeders and Pullets, FeatherSoft Hi-Flow Nipples with LitterGard Cups are the perfect choice for optimum flow and precise delivery of water to birds of all ages.



Feathersoft™ Nipples

The patented 360° triggering FeatherSoft™ Layer Nipple offers many features and benefits that will make a difference to your bottom line.

360° TRIGGERING - Easy triggering of the pin provides a plentiful supply of water to birds of all ages.

ONE NIPPLE FROM START TO FINISH - Birds are raised on the same nipple that they will use for egg production.

RAISED WATER ENTRY POINT Eliminates the possibility of sediments entering the nipple assembly.

TROUBLE FREE - Layer Nipples have only 3 parts: body, metering pin and triggering pin and DO NOT include O-rings, seals or steel balls.

20 MICRON TEST - Feathersoft reduces the risk of blocked water flow by allowing particles up to 20 microns to pass through the nipples.

LitterGard™

LitterGard™ cups are designed to catch any water spillage caused by the aggressive triggering of larger birds, thus improving litter conditions throughout the building.



ONE-ARM LITTERGARD™ TWO-ARM LITTERGARD™





Breeder Systems

Breeder Nipple with LitterGard™

Number of Birds per Nipple
 10-12 - Breeder Nipple with LitterGard.
 8-10 - Breeder Nipple with LitterGard for Males.

Nipples per 10' Section - Standard
 10-15 nipples per 10' (3 m) Section.

Max. Recommended System Length
 250' (80 m) per Regulator.

Water Pressure Requirement - 250' Length
 Pressure Regulator: min. 20 psi (1.380 bars) max. 45 psi (3.103 bars).



Pullet Systems

FeatherSoft™ Nipple with or without LitterGard™

Number of Birds per Nipple
 10-12 - FeatherSoft Advantage.
 12-15 - FeatherSoft Advantage with LitterGard.

Nipples per 10' Section - Standard
 8 - 12 nipples per 10' (3 m) Section.

Max. Recommended System Length
 250' (80 m) per Regulator.

Water Pressure Requirement - 250' Length
 Pressure Regulator: min. 20 psi (1.380 bars) max. 45 psi (3.103 bars).

Watering sections include:

- 10' (3 m) long, square, PVC, pipe
- Nipples with or without LitterGard™
- Expansion coupler with stainless steel crimping rings
- 10' (3 m) aluminum support rail
- 4 plastic holding clips
- Galvanized connectors, 4 nuts and bolts
- 5 Hangers



Watering sections are shipped completely preassembled. Only galvanized connectors and hangers are not assembled. Watering sections are packed in cartons that are protected, carefully banded and shipped on skids.

HH2O System Overview

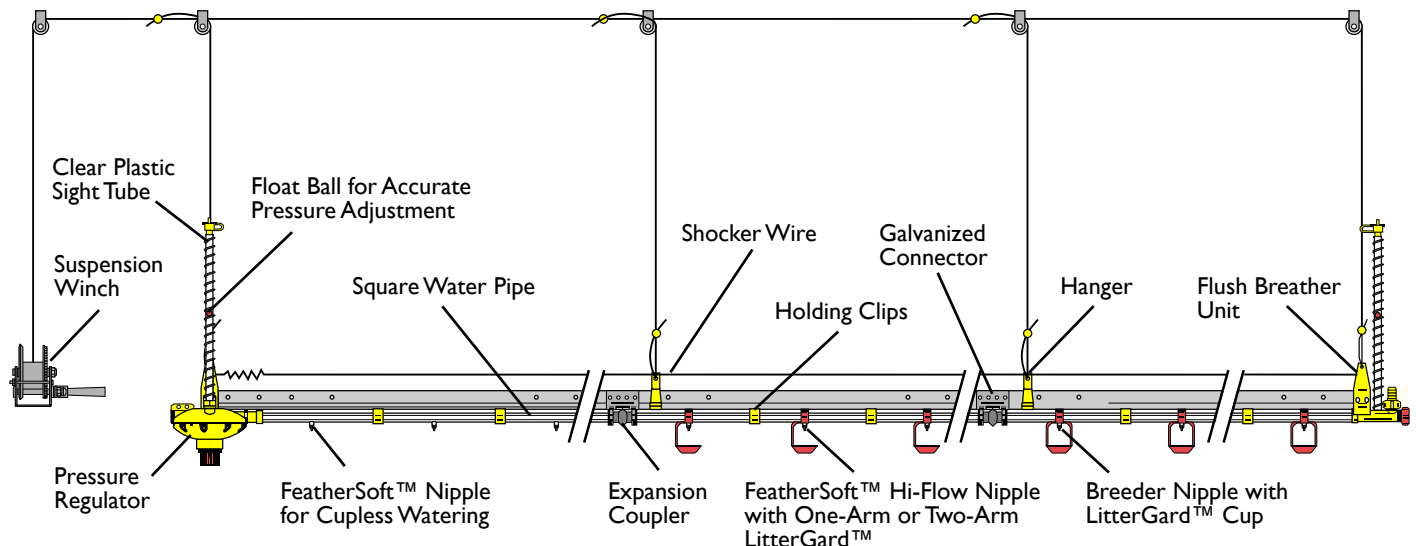

Front Roll-Out Nesting Systems

Combined with proper breeder management practices, Cumberland's nesting systems can help you achieve excellent results with minimal labor and maintenance costs. Cumberland's Front Roll-Out Nest is available in 16 or 20 hole, double belt models.

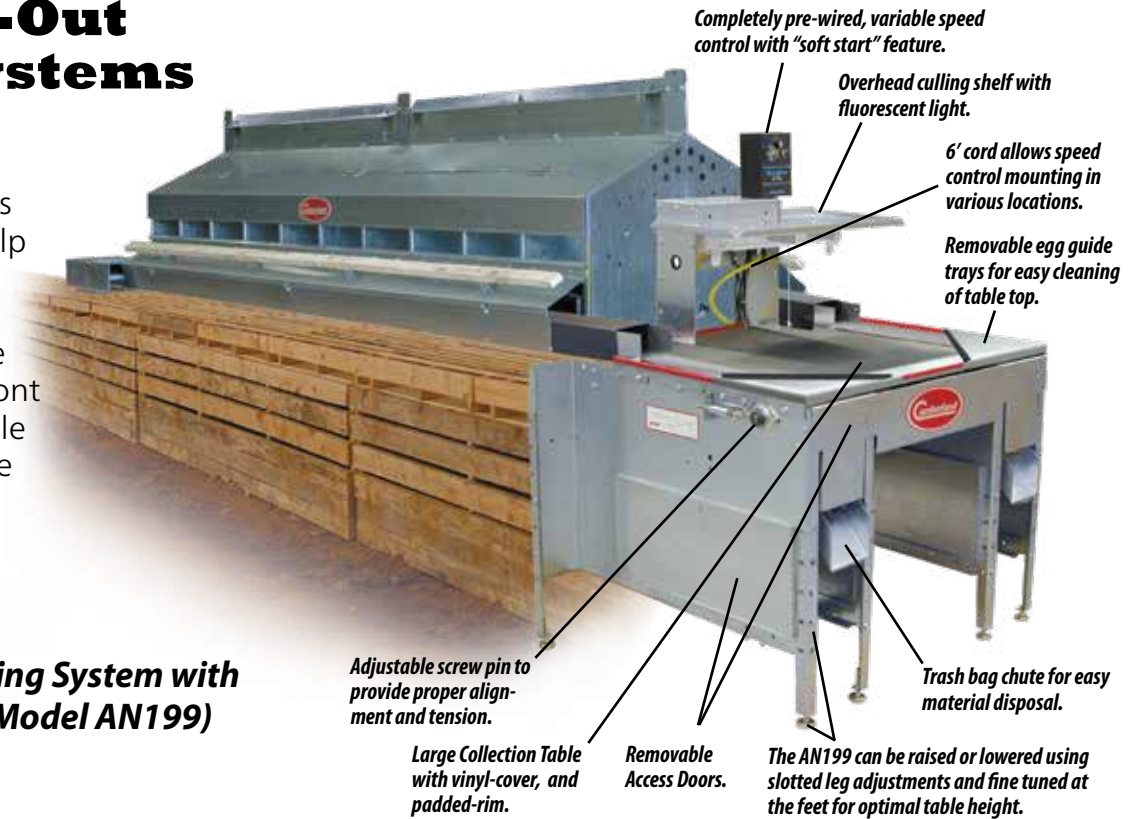

Front Roll-Out Nesting System with Collection Table (Model AN199)



Convenient front access allows for egg collection in the event of a power failure and provides easier cleanout and maintenance without extensive and time consuming disassembly.



The front roll-out nest features a hinged lid which conveniently lifts or closes to block nest access.

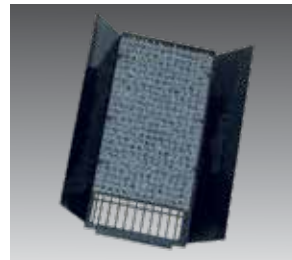

Front roll-out nests utilize grey crushed leaf nest pads with a durable, easy to clean, plastic nest bottom.

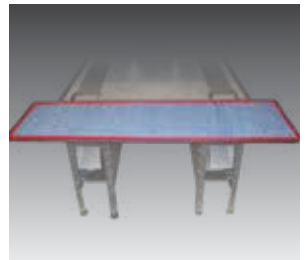

For increased egg storage during collection, a removable extension tray is an available option for the front roll-out collector table.



Center Roll-Out Nesting Systems

The single belt, Center Roll-Out Nest features a comfortable, safe and easily accessible laying area reducing bird stress and promoting enhanced hatchability. Available in 12 hole and 10 hole units, this nest is a durable and dependable choice.

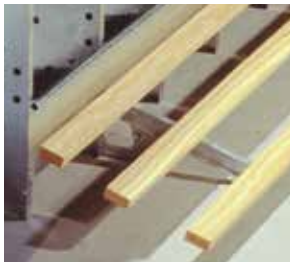

For center roll-out nests, an optional wooden perch is available with double-riveted support brackets to eliminate sway. The perch can be raised and locked to control accessibility.



Available for 12 hole nests, the center roll-out nest pads are easy to clean and provide a comfortable and inviting laying area. The crushed leaf pad design promotes proper roll-out with minimal egg contact.



Plastic, corrosion resistant nest bottom has large openings from the front of the nest to the back keeping litter from building up without losing any strength. It's contoured design helps funnel eggs to the belt with ease.



Cumberland offers egg collection tables to suit your particular front or center roll-out nesting system.

Model AN893

- Hinged egg diverter for easy access to the belt.
- Adjustable overhead culling shelf with fluorescent light.
- Plastic sweep arm to gently guide the eggs.
- Vinyl-covered, padded-rimmed collection table.
- Completely pre-wired, variable speed control with "soft start" feature.
- 6' cord allows speed control mounting in various locations.
- Trash bag chute for easy material disposal.
- Can raise or lower using slotted leg adjustments and fine tune at the feet for optimal table height.

Model AN392

- Completely pre-wired, variable speed control with "soft start" feature.
- 3' cord allows speed control mounting in various locations.
- Table top available in left or right side orientation.

Additional Nest Features & Accessories



BELT ROLLERS

Belt rollers are made of heavy-duty plastic and are adjustable with a simple screw pin. A fiber brush clears debris off the return belt.



BELT TIGHTENER

Each table features a spring loaded, self-adjusting belt tightener with automatic shutdown and a front clean out with a belt brush to continuously remove debris from the line.



NEST BOTTOM RODS

The nest bottom rods support the nest bottom without the need for ledges that can cause litter build up. Adjustable nest bottom rods will help facilitate safe egg roll out.

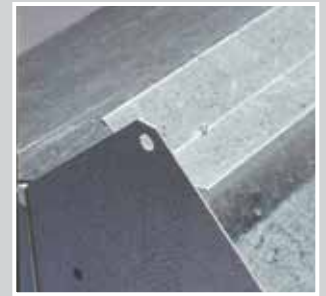

ANTI-ROOST DEVICE

A simple but effective anti-roost device, and a steep pitched roof, keep birds from roosting on the houses promoting a cleaner environment and longer equipment life.

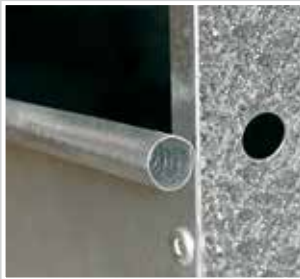

HEMMED AND ROLL FORMED PARTS

Hemmed and/or roll formed parts eliminate bird injury or bruising caused from exposed metal edges.

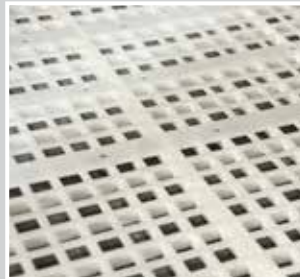

POULTRY FLOORING

Cumberland's poultry flooring reduces foot pad problems, leg problems, and breast blisters often experienced with wood slats. It's easier to clean and will easily outlast wood slats as well.

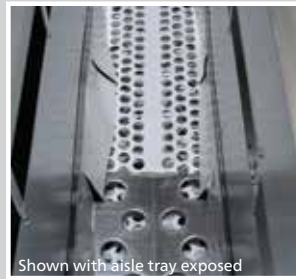

PLASTIC BELT

Optional plastic belt is available for easy cleanup and lasting durability. The perforated belt and aisle trays allow refuse to drop clear while providing reliable egg transport.



TRAYS AND COVERS

Eliminate the expense of continuously replacing corroded metal aisle covers with vinyl aisle covers available for recessed or non-recessed installations. Galvanized aisle trays provide a durable path for the belt and eggs.

Optional Nest Closure Kits

Nest Closure Kits can be installed to keep birds from entering the nests. A simple winching system slowly lowers a closure bar into place as to not alarm the birds. Nesting birds can easily exit with the closure bar in place.



CENTER ROLL-OUT NEST CLOSURE KIT



FRONT ROLL-OUT NEST CLOSURE KIT

Easily Manage Your Feed Inventory

Eliminate the dangerous task of climbing bins to check feed levels and decrease labor cost with a Cumberland Bin Scale System.

EDGE® Bin Scale

The EDGE® Bin Scale offers EDGE control users extensive feed management benefits with remote access. Receive low-feed notifications as well as 180-day history on the controller including bin weight, auger run times, feed deliveries, and more.



For convenient, reliable, and accurate feed bin weighing, the **PRECISION*** load cell is available for the EDGE bin scale system. Rated at 10,000 lbs. (4,500 kg.), PRECISION load cells are pre-calibrated for easy setup and include a convenient built-in lifting mechanism for simple installation.



*PATENT PENDING

Feed-Link™ Bin Scale

The Feed-Link system provides a cost-effective method of monitoring and managing on-site feed inventory either at the site or from a remote location. Feed-Link can be easily adapted to new or existing facilities to provide accurate real-time data regarding feed inventory levels and feed consumption.



5,000 OR 10,000 LB. FEED-LINK LOAD CELL

5,000 LB. FEED-LINK LOAD CELL WITH LIFTING

10,000 LB. FEED-LINK LOAD CELL WITH LIFTING

Four models of load cells are available; a standard unit (with or without lifting) for up to 5,000 lbs. (2,250 kg.) per bin leg and a high capacity model (with or without lifting) rated at up to 10,000 lbs. (4,500 kg.) per bin leg. The compact designs of the load cell assemblies only increase the overall height of the feed bin by approximately three inches (eight centimeters). All Feed-Link load cells are compatible with the EDGE 3-wire bin scale system.

Weighing Systems to Fit Your Needs

6' OR 7' BIN SCALES

Choose from a 5,000 lb. (2,268 kg) capacity 6' (1.83 m) tank scale, 10,000 lb. (4,536 kg) capacity 7' (2.13 m) tank scale or a complete load cell package for out-of-house weighing of feed.



ROOSTER SCALE

Cumberland's 650 lbs. (295 kg) hanging hopper scale will provide accurate daily weighing needed for the male feeding system.



PLATFORM SCALE

For in-house weighing, a platform scale is available with either 1800 pound (816 kg) or 4000 pound (1814 kg) capacity hoppers.

Galvanized Steel Fans

All galvanized fans are constructed of heavy gauge, G-90 grade galvanized steel and use totally enclosed "TEAO" motors designed for high efficiency and continuous duty cycles.

Mega Flow Butterfly Fans 36", 50", 52" and 54" Diameter

Mega Flow Butterfly Series Fans have been re-engineered for improved air flow and greater efficiency. Available in 36", 50", 52" and 54" diameters, Mega Flow Butterfly fans are easy to install, extremely low maintenance and include many new features designed to save you time and money.

- Front shutter doors offer protection while the fan is not in use from harsh weather conditions such as wind and moisture
- Arched side cone panels allow Cumberland fans to be mounted closer together on field installation
- Large pulleys allow for longer belt life and smooth operation. An automatic belt tensioner ensures proper belt tension
- Air diverters for improved airflow



- Strong ring weldment with rod and V-channel vertical
- Revised baffle spring attachments
- Neoprene baffle hinge for smooth, consistent operation
- Large, cast iron, high quality greasable pillow block bearings are used for longer life
- Bell or cage inlet options



Flush Mount Panel Fan

More airflow and easy installation

Cumberland is proud to introduce the Flush Mount Panel Fan to meet your specific high efficiency or high airflow requirements. The flush mount design features a tight seal to limit light and air leakage, collapsible sides for closer fan installation, and adaptability to a wide range of rough opening sizes for easy installation or retrofit.

- Mounts to the outside of the frame opening
- Can be installed on 5-foot centers
- Tight seal limits light and air leakage
- Collapsible sides allow more fans on a wall
- Heavy-duty, galvanized cone, venturi and props
- Adapts to a existing rough opening sizes for easy retrofit capability
- 2-year motor warranty





Slantwall Fan

- Available in 36", 50" and 54" diameters
- Aerodynamically balanced propellers for maximum airflow
- Heavy-duty, galvanized cone, venturi and props
- 2-year motor warranty

SHOWN WITH OPTIONAL DISCHARGE CONE



Box Fans

- Available in 36" dia. (14" and 19" depth) or 50" dia. (21" and 25" depth)
- Aerodynamically balanced props for maximum airflow
- Heavy-duty, galvanized steel housings, venturis and propellers.
- 2-year motor warranty

GALVANIZED SLANTWALL, SLANTWALL CONE & BOX FAN PERFORMANCE VALUES

Model	Dia.	Drive	Type	HP	0.0 Static Pressure		.05 Static Pressure		.10 Static Pressure		BESS Lab Test#
					CFM	CFM/Watt	CFM	CFM/Watt	CFM	CFM/Watt	
CGSB36	36"	Belt	Slantwall	0.5	10578	19	9984	17.1	9379	15.5	98273
G50SL16GA	50"	Belt	Slantwall	1	22373	18.6	21042	17	19595	15.5	98283
CGSD36	36"	Direct	Slantwall	0.5	10417	17.5	9747	15.8	9105	14.2	94-0015
CGSD50	50"	Direct	Slantwall	1.25	20400	19.2	19300	17.5	18100	15.8	94328
CGBB3614	36"	Belt	Box	0.5	10171	19.6	9615	17.8	8969	15.8	00128
CGBB5021	50"	Belt	Box	1	20861	20.9	19486	19.1	18071	17.4	94276
CGBD3614	36"	Direct	Box	0.5	10950	19.3	10280	17.7	9560	16	94131
CGBD5021	50"	Direct	Box	1.25	20450	19.09	19200	17.8	17910	15.9	94283
CGSBC36	36"	Belt	SW Cone	0.5	11341	20.9	10653	18.4	9898	16.4	98275
G50SCL16GA	50"	Belt	SW Cone	1	24700	22.5	23100	20	21500	17.7	3168
G54SCL16GA	54"	Belt	SW Cone	1.5	28900	27.1	26700	23.6	24300	20.4	-
G54SCL16GHF	54"	Belt	SW Cone	1.5	30856	24.0	29184	21.3	27185	18.8	-

* Performance values of this fan at .05" static pressure exceeds the BESS Lab test capabilities and were calculated through regression analysis of CFM and CFM/Watt measurements.



GALVANIZED BUTTERFLY FAN PERFORMANCE VALUES

Model	Dia.	Drive	HP	0.0 Static Pressure		.05 Static Pressure		.10 Static Pressure		.15 Static Pressure		.20 Static Pressure		BESS Lab Test#
				CFM	CFM/Watt	CFM	CFM/Watt	CFM	CFM/Watt	CFM	CFM/Watt	CFM	CFM/Watt	
77-0104-IB	36"	Belt	0.5	-	-	11065	17.4	10575	16.1	-	-	-	-	NA
77-0100-IB	36"	Belt	0.5	12580	19	11700	16.5	10840	14.5	9940	12.7	8950	11.1	8265
77-0109-IB	50"	Belt	1.5	25238	27.4	23524	24.0	21800	20.8	19400	17.7	17000	14.9	4309-C
77-0110-IB	50"	Belt	1.5	23915	30.2	22131	25.9	19937	22.1	17700	18.5	15100	15	4310-C
77-0111-IB	50"	Belt	1.5	26913	24.2	25427	21.5	23603	18.9	21600	16.4	19500	14.2	4308-C
77-0118-IB	52"	Belt	1	29300	25.6	27700	22.6	25900	19.6	23700	16.9	21500	14.5	5336
77-0117-IB	52"	Belt	1.5	27600	29.1	25900	25.2	23800	21.7	21500	18.2	18800	15.2	5340
77-0121-IB	52"	Belt	1	27800	28.3	26000	24.2	24000	21.0	21300	17.5	18900	14.7	5337
77-0122-IB	52"	Belt	1.5	30700	25	29200	22.1	27500	19.4	25600	17	23400	14.7	5338
77-0143-IB	54"	Belt	1.5	32300	22.9	30800	20.5	29300	18.4	27500	16.4	25400	14.4	14156
77-0144-IB	54"	Belt	1.5	31800	23.7	30300	21.2	28700	19.0	27000	17.0	23900	14.0	14157
77-0145-IB	54"	Belt	1.5	31100	24.6	29700	21.9	28000	19.5	26200	17.4	23900	15.0	14185
77-0146-IB	54"	Belt	1.5	30800	25.0	29500	22.5	27800	20	25800	17.6	23600	15.2	14182
77-0147-IB	54"	Belt	1.5	30000	26.4	28400	23.5	26600	20.7	24600	18.0	22300	15.6	14159
77-0148-IB	54"	Belt	1.5	29600	27.5	27900	24.1	26100	21.2	24100	18.7	21800	15.8	14158
77-0149-IB	54"	Belt	1.5	29200	27.7	27600	24.4	25800	21.6	23700	18.6	21200	15.9	14183
77-0150-IB	54"	Belt	1.5	28400	27.7	26700	24.4	24900	21.6	22500	18.6	20100	15.9	14160
77-0151-IB	54"	Belt	1.5	27800	30.5	26000	26.4	24000	22.7	21600	19.3	18000	15.1	14172

NOTE: Listed RPM at .10" static pressure.

HIGH-EFFICIENCY FLUSH MOUNT PANEL FAN

591 to 594 RPM with 0.10 static pressure. Our most energy efficient flush mount fan option.



STATIC PRESSURE (IN H ₂ O)	AIRFLOW (CFM)	RPM	VOLTS	AMPS	WATTS	CFM/WATT
0.00	29500	594	230.1	5.11	1128	26.1
0.05	28200	593	229.7	5.41	1191	23.7
0.10	26500	592	229.7	5.71	1260	21.0
0.15	24800	591	230.2	6.03	1334	18.6

HIGH-FLOW FLUSH MOUNT PANEL FAN

628 to 633 RPM with 0.10 static pressure. Our highest RPM flush mount fan option moving up to 520 cu. ft. per second.

STATIC PRESSURE (IN H ₂ O)	AIRFLOW (CFM)	RPM	VOLTS	AMPS	WATTS	CFM/WATT
0.00	31200	633	231.5	5.97	1329	23.4
0.05	30000	631	230.4	6.37	1410	21.3
0.10	28600	630	229.7	6.71	1482	19.3
0.15	26800	628	229.7	7.06	1559	17.2

Fiberglass Fans

Cumberland's fiberglass fans are manufactured using a resin transfer molding process for a smooth finish on both interior and exterior surfaces of the fan housing.

58C Series Fans

Get powerful ventilation from our highest performing fan featuring a spring* loaded butterfly door design with a magnetic locking mechanism for a complete seal.

- 58" diameter fan with non-corrosive fiberglass reinforced composite venturi and housing
- Tight sealing butterfly door design reduces air leakage and light infiltration
- Preassembled butterfly doors and standardized fasteners make assembly quick and efficient
- Non-corrosive composite cone available



58C Series



Light weight, insulated poly butterfly dampers open and close automatically with the operation of the fan.



Rigid x-wing motor mount design and reinforced corner bracing add strength and solid support with minimal air flow obstruction.



Standard, automatic belt tensioner and large, cast iron, greasable pillow block bearings for longer life.



An extended housing allows the fan to be mounted flush with the internal wall surface. The flush mount design allows retrofit over wall openings from 57.5" to 63".

58C FAN PERFORMANCE VALUES

Part#	Type	.10 Static Pressure		.15 Static Pressure		.20 Static Pressure		Air Flow Ratio	Bess Labs Test No.	Power
		CFM	CFM/Watt	CFM	CFM/Watt	CFM	CFM/Watt			
77-0185	High Flow	30,000	20.5	28,300	18.6	26,200	16.7	0.83	17305	230V, 60Hz, 1PH
77-0183	High Efficiency	26,700	22.6	24,800	20.3	22,500	17.9	0.78	17304	230V, 60Hz, 1PH
77-0188	High Flow	29,400	20.6	27,600	18.5	25,700	16.7	0.83	17211	230V, 60Hz, 3PH
77-0189	High Efficiency	27,100	22.8	25,000	20.2	23,000	18.0	0.80	17210	230V, 60Hz, 3PH

58C FAN DIMENSIONS

A	B	C	D	E	F	Recommended Wall Opening
12.25"	45.00"	16.13"	68.13"	76.00"	65.75" x 65.75"	66.00" x 66.00" **

** For flush mount installations, the Mega Flow 58C will accommodate openings from 57.5" to 63" square. Fan to Fan spacing on wall with poly cone: 76"

*Patent Pending

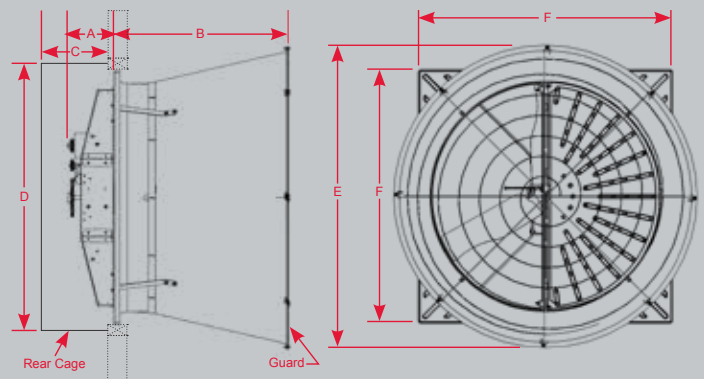



Performer Series

Models available with or without cones



Competitor Series

Performer Series Fans

High performance, efficiency, and longevity make the 36" and 50" Performer series fans a popular choice for optimal airflow. Propellers



are made of a tough composite fiberglass and engineered with a true airfoil design that increases the overall efficiency of the fan. Drive shafts of 1" material allow for large, cast iron, greasable pillow block

bearings to be used for longer life. Large pulleys allow for longer belt life and smooth operation.

Competitor Series Fans

Capable of moving up to 30,000 cubic feet of air per minute, Competitor Series fans are another powerful tool to help you compete in today's world



marketplace. Features include a 1.75 HP single or three phase motor, easy belt access, fiberglass housing and cone, and stainless steel hardware. The belt driven 54" competitor series fan features an automatic belt tensioner for smooth

operation. Like all Cumberland belt drive fiberglass fans, cast iron pulleys and greasable pillow block bearings are standard features.

PERFORMER AND COMPETITOR FAN PERFORMANCE VALUES

Model	Dia.	Drive	Cone	HP	0.0 Static Pressure		.05 Static Pressure		.10 Static Pressure		BESS Lab Test #
					CFM	CFM/Watt	CFM	CFM/Watt	CFM	CFM/Watt	
APPB-36	36"	Belt	No	0.5	10952	16.1	10152	15.4	9339	14	-
APPB-36C	36"	Belt	Yes	0.5	11232	18.2	10905	17.5	10135	15.8	-
APPB-50	50"	Belt	No	1	21508	17.6	20160	15.7	18707	14.4	-
APPB-50C	50"	Belt	Yes	1	24282	23.4	22760	21	21129	19	01251
CS54C1-P	54"	Belt	Yes	1.75	32125	-	30044	20.2	28157	18.3	-

Cumberland shutters can provide an easy and affordable means of controlling incoming light and building climate. Shutters are available in white or black PVC, galvanized with epoxy painted blades and durable aluminum.



Factory assembled, pre-wired, 20" circulation fans are available for light air movement. These highly efficient 20" fans include 1/10 HP "TEAO" motors and galvanized props for whisper quiet operation. Other features include PVC coated guards for durability and multi-application hanging bracket.



2-Bladed Circulation Fan

3-Bladed Circulation Fan

Curtain Machines

Protect the health of your investment with a properly controlled curtain system. Cumberland's curtain machines deliver powerful performance and reliable operation with durable components to withstand a rigorous environment.



CURTAIN CONTROLLER

Cumberland's Curtain Controller is a screw driven automated curtain machine with a heavy duty 15, 30 or 60 RPM motor. Multi-directional, frame mounted, header pulleys and latch out assembly come standard.

A plastic water resistant junction box is accessible from the outside of the curtain controller.



The drive block assembly features a removable nylon insert in a heavy-duty cast iron drive block simplifying cable/chain installation and ease of maintenance. This design also decreases friction and provides wear characteristics superior to conventional brass drive blocks. UHMW polyethylene guide wheels insure smooth travel, proper alignment and stability.



Solid construction and rust resistant materials make the sprocket controller a reliable workhorse year after year.



The Curtain Controller utilizes a threaded block and drive screw directly coupled to a direct drive gear motor.



Isolated primary and secondary limit switches allow for backup protection.

Model	H. P.	Voltage	Frequency	AMP Draw	Travel Speed	RPM
15 RPM Curtain Controller	1/12	115V	60 Hz	1.0 Amps	3" per minute	15
30 RPM Curtain Controller	1/8	115/220V	50/60 Hz	1.7 Amps	6" per minute	30
60 RPM Curtain Controller	1/6	115V	60 Hz	1.8 Amps	12" per minute	60
A.T. Newell	1/2	115V	60 Hz	6.0 Amps	3" per minute	1725

Curtain Commander Length	"A" Travel	"B" Width	"C" Length	"D" Width Less Flange	Weight
24" (61 cm)	22" (55.9 cm)	10.2" (25.9 cm)	52" (132.1 cm)	9.5" (24.1 cm)	110 lbs. (49.9 kg.)
36" (91.4 cm)	34" (86.4 cm)	10.2" (25.9 cm)	64" (162.6 cm)	9.5" (24.1 cm)	130 lbs. (58.9 kg.)
48" (121.9 cm)	46" (116.8 cm)	10.2" (25.9 cm)	76" (193 cm)	9.5" (24.1 cm)	150 lbs. (68.0 kg.)
60" (152.4 cm)	58" (147.3 cm)	10.2" (25.9 cm)	88" (223.5 cm)	9.5" (24.1 cm)	160 lbs. (72.6 kg.)

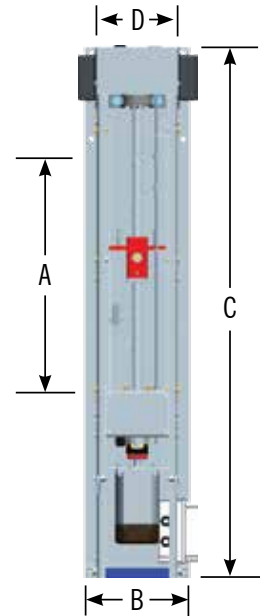

Hardware kits are available with heavy duty galvanized steel components.





POWERTRAK[®] Vent Machine



Operate attic inlets, vent doors, and other items requiring a 12" or less controlled movement at, or under, a 2,000 lb. capacity with the PowerTrak™ Vent Machine. Designed for a wall or ceiling mounted indoor installation, this machine will provide a more cost effective way to operate your vent inlet applications. The PowerTrak Vent Machine is available in 15 or 30 RPM models and can be ordered in either 120v or 240v single phase units. (Note: 240v units available in 50/60hz)

- Machine designed specifically for vent inlet applications
- 15 or 30 RPM - 120v, 60hz, 1ph
- 30 RPM - 240v - 50/60hz, 1ph
- 42.5" overall machine length for tight areas or short walls.
- Maximum travel length on rod is 12"
- Threaded block/drive screw directly coupled to DD gear motor
- Hardware included for cable or chain connection



Composite load nut offers increased life expectancy over brass.



The door hinges from the top of the cabinet on a ceiling mount or can be easily removed on a wall mount for unobstructed access to components.



Channel lock "trak-drive" system captures load block



Easy adjust spring-cam limit switch system



POWERTRAK[®]



With a 5,000 pound capacity, the superior quality and design of the PowerTrak™ linear drive system boasts many performance and durability enhanced features.

- Modular construction for ease of service.
- Built in head bracket with needle bearing pulleys.
- Channel lock "trak-drive" system captures load block.
- 15% increase in load block support surface for greater life.
- Easy adjust spring-cam limit switch system.
- Convenient, easily removable, hinged springlock door.
- Greater protection from the elements.
- Upper and lower auxiliary contact for enhanced Evolution features.



Cumberland's sidewall vent doors are used in poultry applications where transitional ventilation is required.

Part Number	Description	CFM @ .10 SP	Rough Opening
SWI-1700	Curved Sidewall Vent w/Plastic Door & Galvanized Frame	2,250	10.75" x 41.5"
SWI-2000	Curved Sidewall Vent w/ Plastic Door & Galvanized Frame	2,550	10.5" x 46"



The all plastic Curved Sidewall Vent Door directs fresh air into the house along the ceiling toward the peak for gentle air mixing without downdrafts on the birds.



Also available in an all galvanized door construction, Cumberland vent doors are simple to install and provide years of optimum circulation.

Evaporative Cooling Systems

Evaporative cooling systems utilize the natural cooling effect of evaporation to combat seasonal dips in production caused by heat stress.

Made of high quality stainless steel or aluminum, the open top system offers the grower easy access to manage and maintain their evaporative cooling system. This systems' design allows you to see the water jets and easily check water pressure. It also offers access to the spray bar for cleaning.

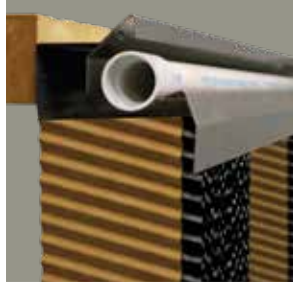

The closed top system is extruded from ultraviolet stabilized PVC for durability and ease of installation. The hinge-open cover and thumbscrews allows accessibility to the spray bar and hold pads firmly in place. The spray bar bracket and water deflector insure pads are uniformly wet.



Cumberland's pre-formed square trough serves as a 3 gallon per lineal foot (44.8 liters per meter) water reservoir. Constructed of corrosion proof, ultra-violet stabilized PVC components, the trough allows unevaporated water to be recirculated back to the holding tank. A perforated tray snaps to the trough to hold pads firmly in place. Injection molded end caps and couplers speed installation.



A roto-molded holding tank offers increased water storage capacity.



Center feed and drain kits are available for longer cooling systems.

OTHER EVAPORATIVE COOLING SYSTEM FEATURES INCLUDE:

- Submersible pump keeps water levels consistent for efficient water delivery
- Automatic float valve for matching water supply with water demand
- Trough support brackets for suspending the system on a sidewall
- Wide selection of cooling pads
- Easy removal of pads for cleaning



JET PUMP FEATURES

- The Jet Pump System provides an external self priming pump.
- Trough mounted float valve eliminates the need for an external tank.
- The Permanent Split Capacitor motor eliminates the start switch and will mount to the wet end of any previous Jet Pump kit.
- Our Jet Pump System is field proven, reliable and a cost effective way to deliver water to Evaporative Cooling Systems.



EVAP COOLING PADS

- Strongest & heaviest pad available
- Produced using the most advanced curing process
- Use the most advanced resin technology
- Superior black diamond edge coating
- Custom sizes from 2' to 6' tall.
- Made in the USA



Cam-Lock system allows toolless pad installation and replacement.



The spray bar bracket and water deflector insure pads are uniformly wet.

RollSeal® Doors

To ensure optimal poultry health, you need to pay careful attention to maintaining the best possible environmental conditions. That means preventing drafts from entering and heat from escaping, making a RollSeal® door the best decision for your operation.

Suitable for any building, new or existing, RollSeal® doors are easy to install and operate and provide years of worry-free environmental control. RollSeal® creates a barrier that keeps the cold out and the warmth in so you know your investment is protected.



RS300 MODEL

- Suitable for all poultry applications
- Sizes up to 14' wide by 14' high
- Custom sizing available so you can find the door that fits your needs



RS400 MODEL

- Ideal for larger applications
- Stronger aluminum channels, drive pipe and larger tension pipes to support longer doors
- Sizes up to 21' wide by 18' high



OPTIONS INCLUDE:

- Additional switches and remote transmitter/receiver options available
- Fabric and window options
- Fabric color options

Patented Triple - Layered Efficiency

Every state-of-the-art RollSeal® door features a tough, tear-resistant patented three-ply fabric of inner and outer layers designed with a durable, long-lasting, hook and loop fastener seal. Each layer works together to provide an energy-efficient double seal, ideal for poultry ventilation applications.

- The upper drive shaft roller lifts and lowers the curtain by the central fabric layer
- By pushing the hook into the loop as the curtain is lowered, two offset lower tension roller bars create the side seal
- Tension rollers hold fabric against the floor for a proper seal
- Patented sealing system provides excellent wind load resistance
- Multilayered, high density, woven-polyethylene fabric has two air pockets that provide good thermal insulation

RollSeal®



Unitized RollSeal® Systems

Cumberland's patented RollSeal® Sidewall System is designed to fit the Komfort Kooler™ Evaporative cooling system with a precision tight fit to limit air infiltration. It utilizes 2 dead air spaces for the best insulating seal and protects cooling pads from inclement weather, dust, UV rays and other harmful environmental elements. Manual and automated drive options are available to best suit your application.

- Superior seal
- 3-layer panel protection
- Pad/System protection from the elements
- 2 dead air spaces to improve insulation value
- Adapts to Komfort Kooler in either the wall mount or direct to concrete versions
- Multiple drive options to best suit your application



Easy Install Easy Operation

Installation couldn't be easier. Simply attach the strong and lightweight aluminum side channels to the head unit, stand the door upright to the frame, bolt the unit in place and you're done. Once installed, your RollSeal® door is simple to maintain and easy to clean.

When you open a RollSeal® door, you'll see how quick and easy it is for anyone to operate the manual chain hoist or the motor drive.

POWER DRIVE AVAILABLE IN...

240v 1ph

208v 3ph

480v 3ph



TIGHT SEAL



MOUNTING BRACKETS

This product may be protected by one or more of the following patents: US5752557, US5960847, US6138739, US6942001, US7828037, AU712128, BR9611473-8, CA2237302, CN325601, EP1338751, IL124347, JP3772992, MX204223, and NO321285



Proven & Dependable™



For more information visit us online at cumberlandpoultry.com
Your Agriculture Company P.O. Box 20; 1004 E. Illinois Street; Assumption, IL. 62510 USA; Ph: 217/226-4401; USA Fax: 800/353-8491; Int'l Fax: 217/226-4420
C-31 1/19 | Copyright © 2019 by AGCO Corporation | Printed in USA | Due to continual improvements, Cumberland reserves the right to change designs and specifications without notice.